

Installation Guide

3 1/2" Ductile Pipe Swing Hanger (SSS-0094-P)

Part List

Tools



Gloves



Safety Glasses

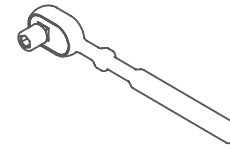

Ratchet

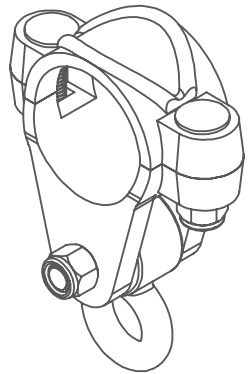

X1

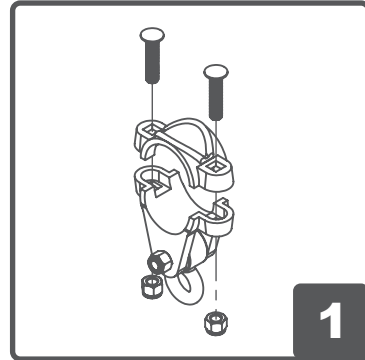

1
Loosen the screws to separate the parts of Swing Hanger.

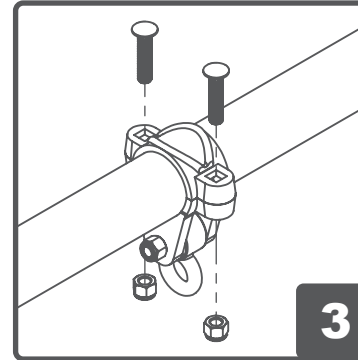

3
Put the screw through the hole and fasten it.

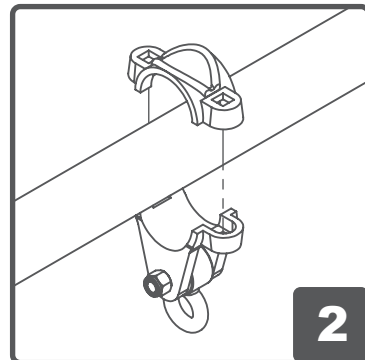

2
Place the top and bottom parts on the pipe.

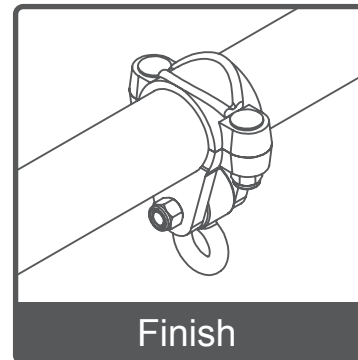

Finish

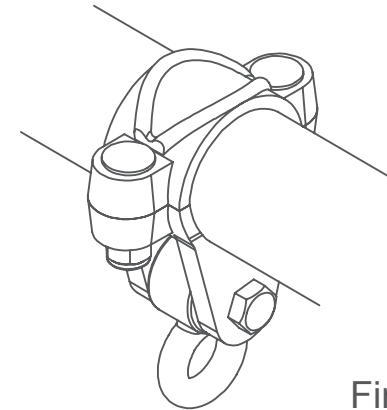

Finish

